

Features:

- Broad bandwidth, specification from 50MHz to 6 GHz, usable from 10MHz to 7 GHz
- Low VSWR, unconditional stable
- Small size, low cost
- SMA female connector I/O
- Single DC power supply, internal voltage regulator, operating voltage from +9~+15V
- Operating temperature -40~+75°C, storage temperature -55~+125°C

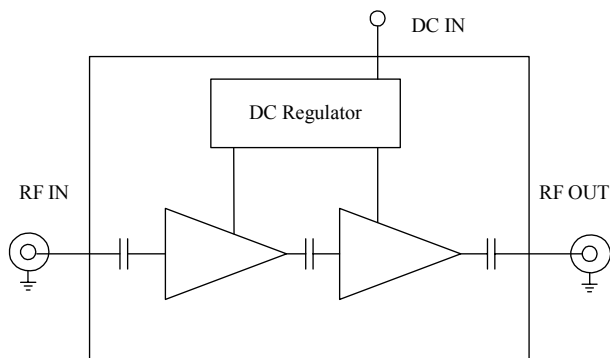

Functional Diagram



Electrical Specifications

Parameters	Minimum	Typical	Maximum
Frequency Range	50 MHz		6000MHz
Noise Figure (from 50MHz)		4.0 dB	4.7 dB
Nominal SS Gain @25°C	30 dB	34dB	37 dB
P-1dB Compression Point	+13.5dBm	+15 dBm	
Gain flatness		+/-2.0 dB	+/-2.5 dB
Gain Variation		+/-1.0 dB	
Input VSWR		1.5:1	2.0:1
Output VSWR		1.5:1	2.0:1
Reverse Isolation	40dB	43dB	
Spurious			-60 dBc
Operating Temperature	-40°C		+75°C
Survival Temperature	-55°C		+125°C
DC Voltage	+9V	+12 V	+15 V
DC Supply Current	90 mA	110 mA	130 mA
In/Out connectors	SMA female		
Size	1.5"x0.85"x0.375		

Mechanical Structure:

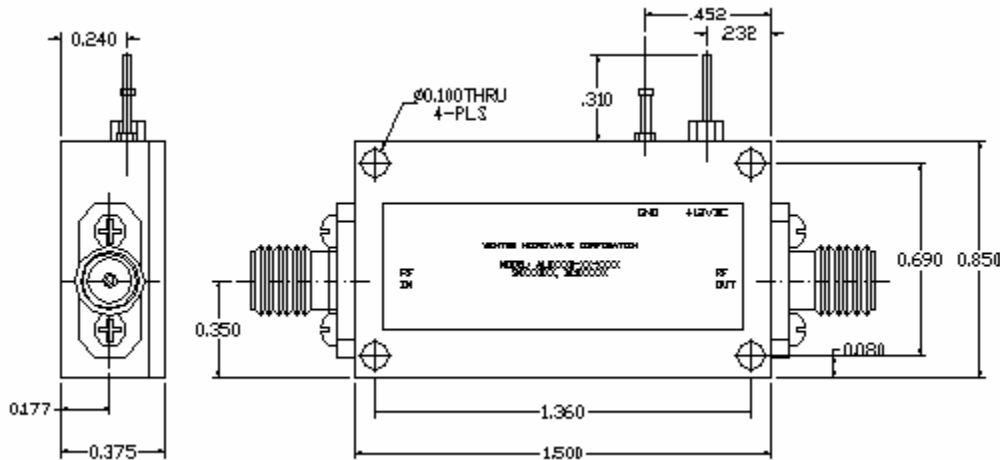

Note: All units in inches.

Typical Test Results:

ABL0600-01-3440 Measured Gain and Return Loss vs Frequency

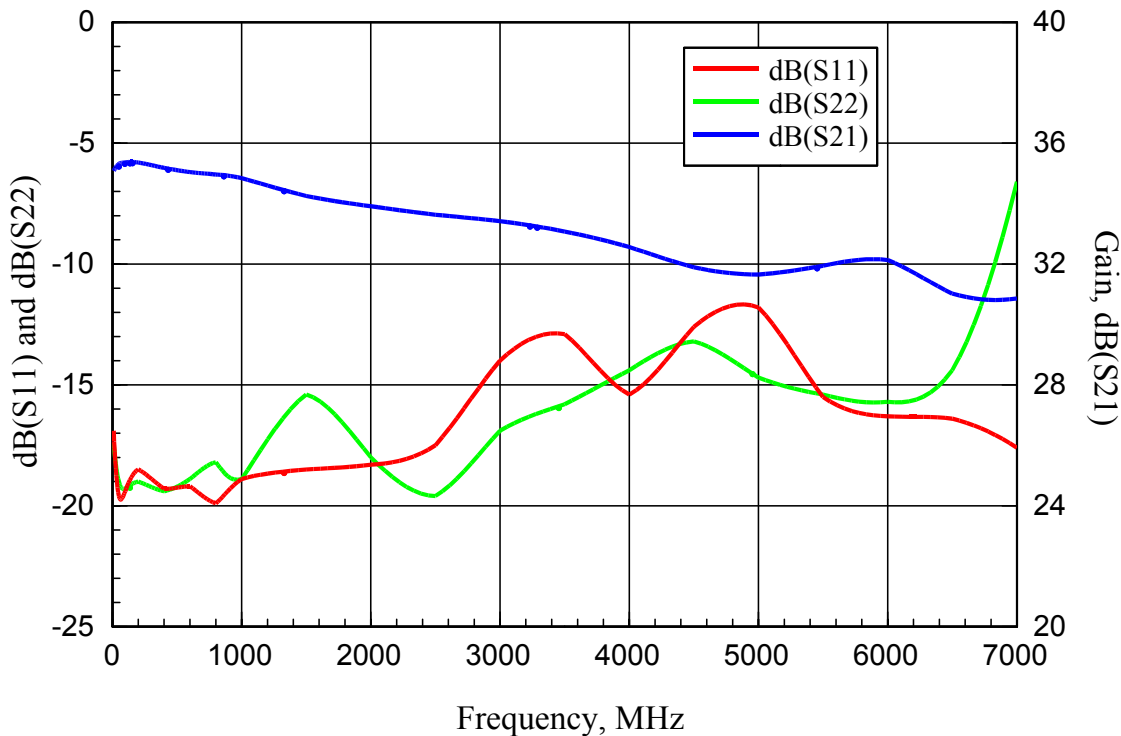

ABL0600-01-3440 Measured Noise Figure vs Frequency

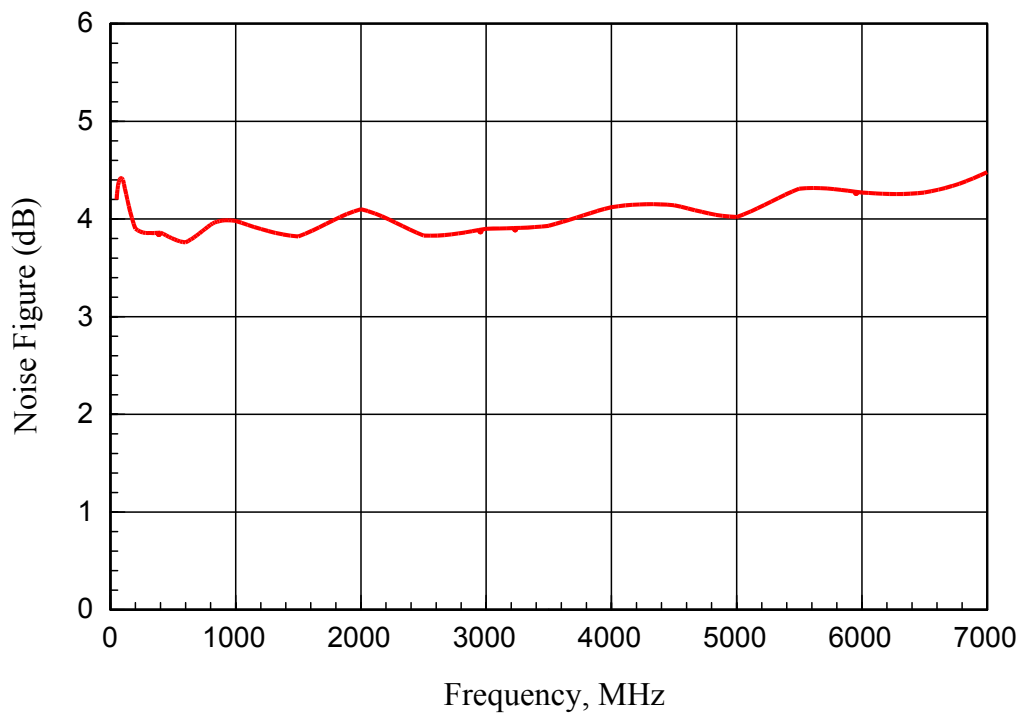

ABL0600-01-3440 Measured Gain and Output Power vs Input Power  
Test Frequency: 100MHz

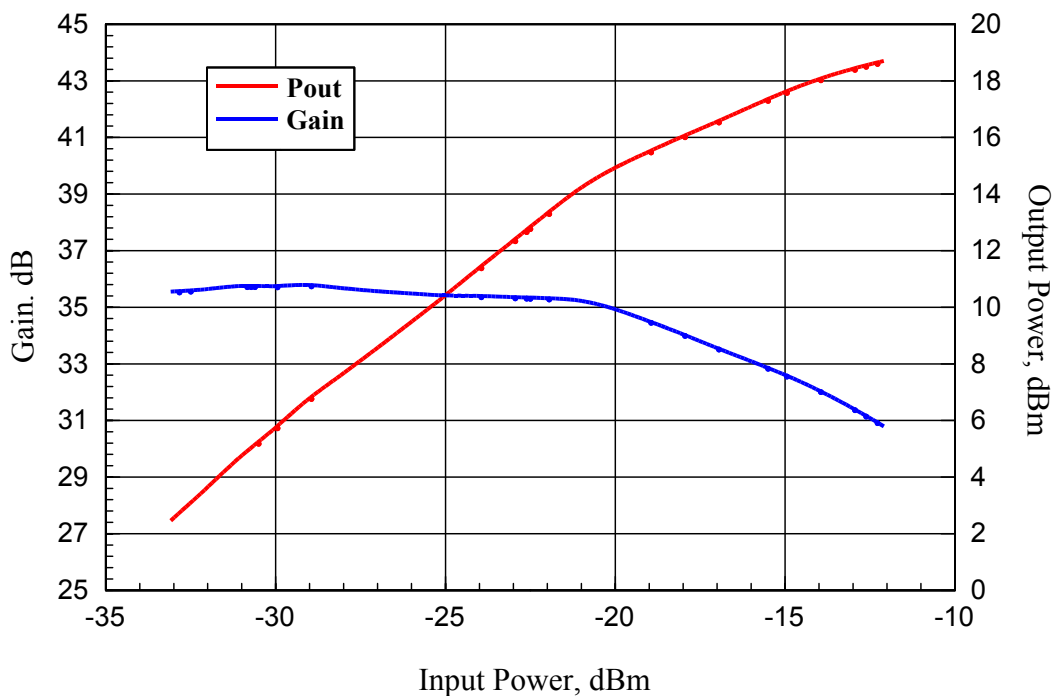

ABL0600-01-3440 Measured Gain and Output Power vs Input Power  
Test Frequency: 3000MHz

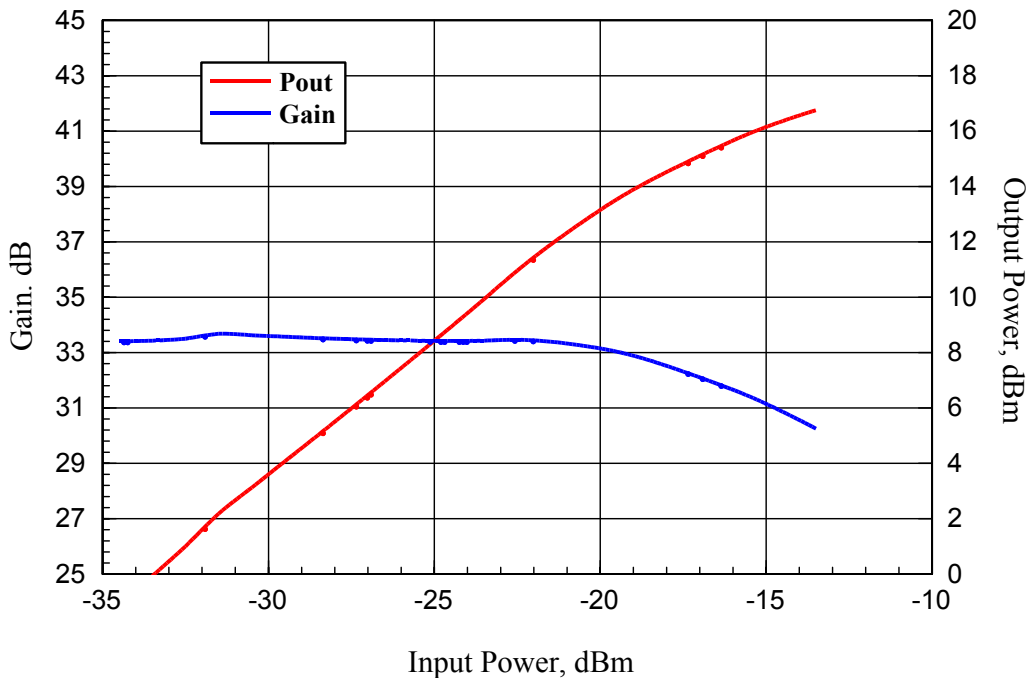

ABL0600-01-3440 Measured Gain and Output Power vs Input Power  
Test Frequency: 6000MHz

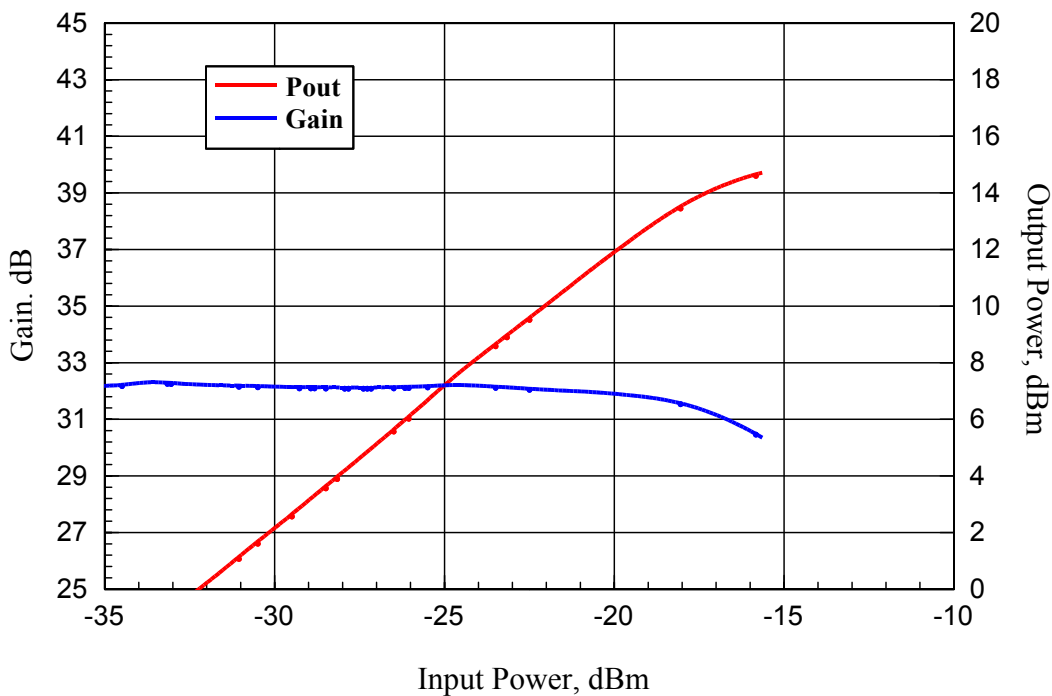



# BROADBAND LOW NOISE AMPLIFIER

## ABL0600-01-3440

---

### Absolute Maximum Ratings

DC Voltage	+15V
RF Input Power	+10 dBm
Storage Temperature	-55~+125°C
Operating Temperature	-40~+75°C